

TUBO FRENO GOMMA A NORMA DOT-SAE J1401  
BRAKE RUBBER HOSE ACCORDING TO DOT-SAE J1401

## ELEMENTI COSTRUTTIVI/CONSTRUCTION

### ANIMA/HOSE CORE

Gomma EPDM  
EPDM rubber

### RINFORZO/PRESSURE REINFORCEMENT

Nr. 1 treccia tessile ad alta tenacità  
Nr. 1 high tensile strength fiber braid

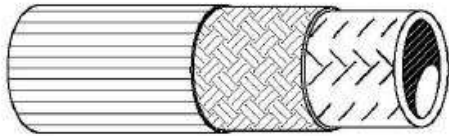

### RIVESTIMENTO/COVER

Gomma sintetica resistente all'abrasione, all'acqua, alla salsedine, all'ozono ed al calore  
Abrasion, weather, high temperature and saltness resistant rubber

### APPLICAZIONI/APPLICATIONS

Particolarmente indicato per impianti frenanti e per impiego di fluidi DOT3 e DOT4  
Suitable for brake plant Suitable for brake plant and for DOT3 and DOT4 fluid

### TEMPERATURE/TEMPERATURE RANGE

-20°C +120°C

Codice Code	Ø				Maximum Working Pressure			Minimum Burst Pressure			Bend Radius	Weight	
	DN	size	inch	mm	mm	MPa	psi	bar	MPa	psi	bar	mm	Kg g/m
TFG1.8	3	02	1/8	3,2	11	12,2	1740	207	49	7000	490	40	100

**RACCORDI MONOPEZZO**



Maschio fisso



Maschio girevole svasato



Maschio girevole bombato



Femmina fissa



Femmina con fermo



Maschio/femmina fisso

RACCORDI PER TUBO FRENO GOMMA A NORMA DOT-SAE J1401  
FITTINGS FOR BRAKE RUBBER HOSE ACCORDING TO DOT-SAE J1401

MASCHIO FISSO CORTO  
FIXED SHORT MALE

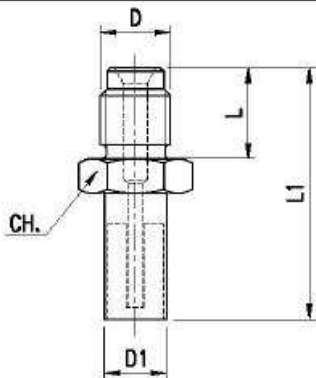

Codice Code	D	D1	L	L1	CH.	Mat.
MACG0	M10x1.25	13	13	40	15	AZ
MACG1	M10x1	13	13	40	15	AZ
MACG2	3/8"-24	13	13	40	15	AZ
MACG12	M12x1	13	13	40	15	AZ
ML11/16G	11/16"-16FIL/1"	13	21	48	19	AZ

MASCHIO FISSO LUNGO  
FIXED LONG MALE

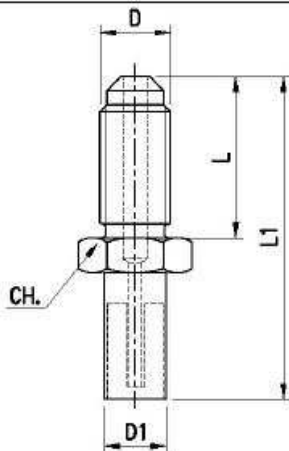

Codice Code	D	D1	L	L1	CH.	Mat.
MALG0	M10x1.25	13	23	47	15	AZ
MALG1	M10x1	13	23	47	15	AZ
MALG2	3/8"-24	13	23	47	15	AZ

MASCHIO GIREVOLE DIRITTO  
STRAIGHT SWIVEL MALE

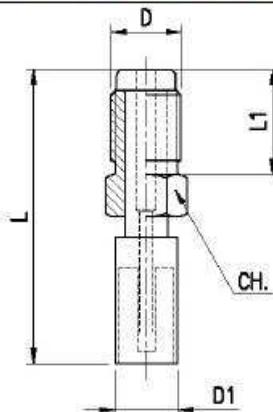

Codice Code	D	D1	L	L1	CH.	Mat.
MAGG0	M10x1.25	13	44	16	10	AZ
MAGG1	M10x1	13	44	16	10	AZ
MAGG2	3/8"-24	13	44	16	10	AZ
MAGG12	M12x1	13	44	16	12	AZ

RACCORDI PER TUBO FRENO GOMMA A NORMA DOT-SAE J1401  
 FITTINGS FOR BRAKE RUBBER HOSE ACCORDING TO DOT-SAE J1401

MASCHIO/FEMMINA FISSO  
 FIXED MALE/FEMALE

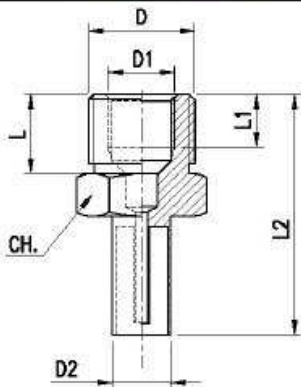

Codice Code	D	D1	D2	L	L1	L2	CH	Mat.
MFALG0	M16x1.5	M10x1.25	13	12	8	40	17	AZ
MFALG1	M16x1.5	M10x1	13	12	8	40	17	AZ
MFALG2	M16x1.5	3/8"-24	13	12	8	40	17	AZ
MFALG12	M16x1.5	M12x1	13	12	8	40	17	AZ

FEMMINA FISSA CORTA  
 FIXED SHORT FEMALE

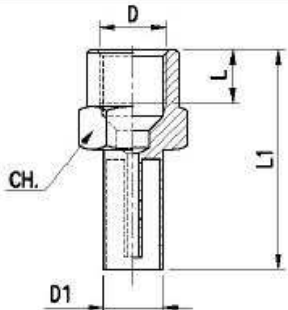

Codice Code	D	D1	L	L1	CH.	Mat.
FACG0	M10x1.25	13	8	37	14	AZ
FACG1	M10x1	13	8	37	14	AZ
FACG2	3/8"-24	13	8	37	14	AZ

FEMMINA FISSA LARGA  
 FIXED LARGE FEMALE

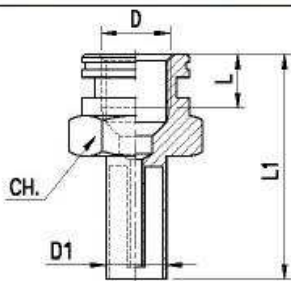

Codice Code	D	D1	L	L1	CH.	Mat.
FALG0	M10x1.25	13	8	37	17	AZ
FALG1	M10x1	13	8	37	17	AZ
FACG2	3/8"-24	13	8	37	17	AZ

GHIERA  
 NUT

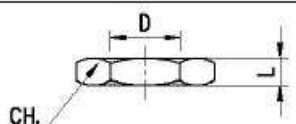

Codice Code	D	L	CH.
MAGG0	M16x1.5	4	19